

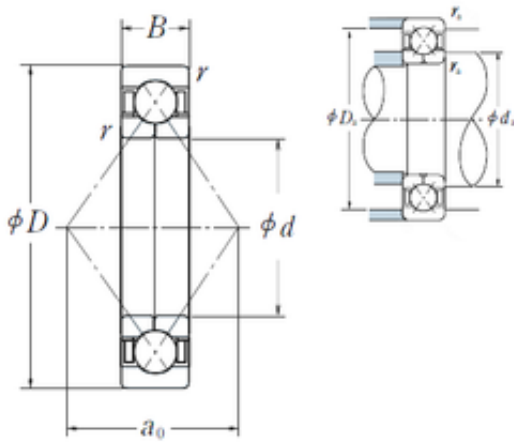

SKF BEARING MANUFACTURING CO.,LTD.



170 mm x 310 mm x 52 mm NSK QJ 234
angular contact ball bearings

Bearing No. QJ 234

Size	170x310x52 mm
Bore Diameter	170 mm
Outer Diameter	310 mm
Width	52 mm
d	170 mm
D	310 mm
B	52 mm
C	52 mm
Angle (°)	35 °
a	168 mm
r min.	4 mm
da min.	188 mm
da max	292 mm
ra max.	3 mm
Weight	19,5 Kg
Basic dynamic load rating (C)	425 kN
Basic static load rating (C0)	1180 kN
(Grease) Lubrication Speed	1 600 r/min

QJ 234 Bearing 2D drawings and 3D CAD models